

## IMPORTANT SAFETY INSTRUCTIONS

- Be sure the electricity to the system you are working on is turned off; either the fuse removed or the circuit breaker set at off.
- Use of other manufacturers components will void warranty, listing and create a potential safety hazard.
- If you are unclear as to how to proceed, contact a qualified electrician.
- You don't need special tools to install this fixture.
- Be sure to follow the steps in the order given.
- Read instructions carefully.
- Save these instructions.

## ORDERING PARTS

Keep this sheet for future reference, and in case you need to order replacement parts. All parts for this fixture can be ordered from place of purchase. Be sure to use exact wording from illustration when ordering parts.

## CLEANING

To clean, wipe fixture with a soft cloth. Clean glass with a mild soap. Do not use abrasive materials such as scouring pads or powders, steel wool or abrasive paper.

## BEFORE YOU BEGIN

Carefully remove the fixture from the carton and check that all parts are included, as shown in figure 1. Be careful not to misplace any of the screws or parts which are needed to install this fixture.

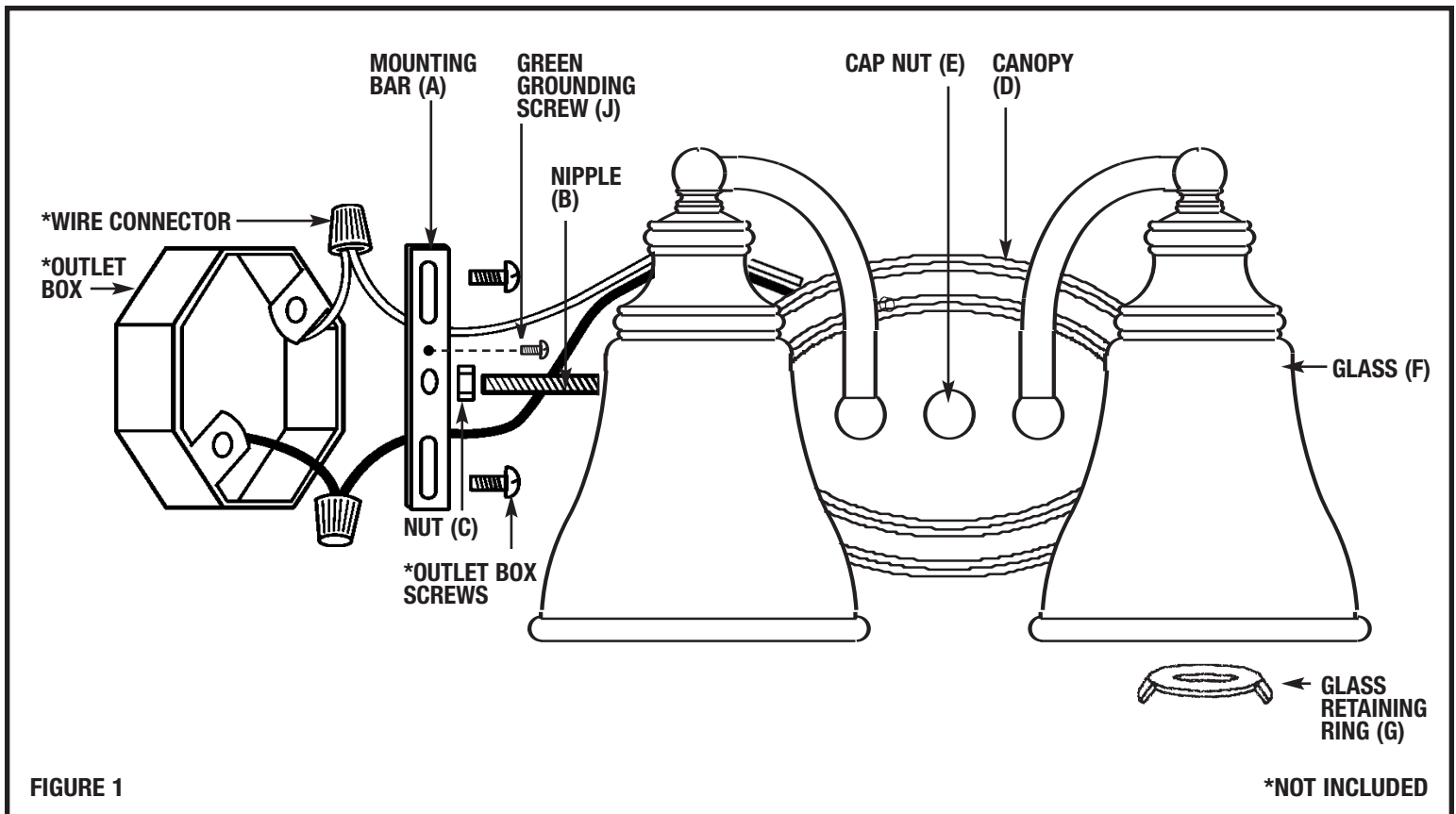

**IMPORTANT: DO NOT ATTACH FIXTURE DIRECTLY TO OUTLET BOX.**

**STEP 1:**

Using outlet box screws (not supplied) fasten mounting bar (A) to outlet box through slots in mounting bar (A).



**STEP 2:**

Thread nut (C) onto nipple (B) so that 5 threads are exposed above nut (C). Thread that end of the nipple (B) into mounting bar (A) and tighten nut (C) against mounting bar (A).

**STEP 3:**

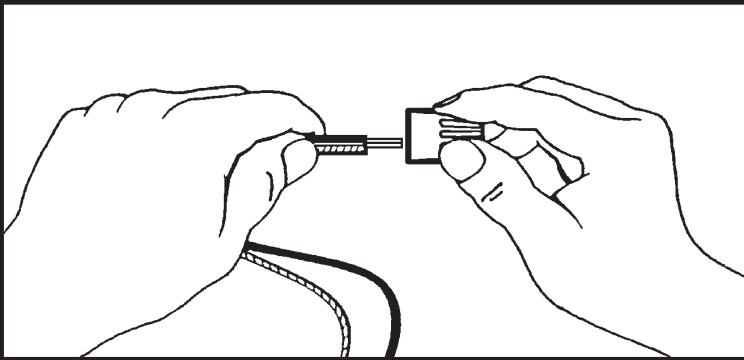
**A.** Take note of the color of the wire(s) on your fixture. Identify which group your fixture wire(s) falls into and connect the wires according to the directions below:

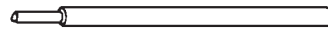
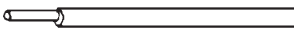

<b>GROUP A: CONNECT TO BLACK HOUSE WIRE</b>	<b>GROUP B: CONNECT TO WHITE HOUSE WIRE</b>
<b>BLACK</b> 	<b>WHITE</b> 
<b>*PARALLEL WIRE (ROUND &amp; SMOOTH)</b> 	<b>*PARALLEL WIRE (SQUARE &amp; RIDGED)</b> 

**A.** Take note of the color of the wire(s) on your fixture. Identify which group your fixture wire(s) falls into and connect the wires according to the directions below:

\*Note: When parallel wire is used, the tracer wire is square shaped or ridged and less tracer wire is round in shape or smooth (Seen best when viewed from wire end). To separate wires, grasp the ends of each wire and pull apart.

**B.** Take your fixture wire(s) from group A and place evenly against the black wire from the outlet box. **DO NOT** twist wires together before using wire connectors.

**C.** Fit a wire connector (not supplied) over the wires and thread the connector clockwise until you feel a firm resistance.

**D.** Gently try to remove the wires from the connector, If you can remove the wires, carefully re-do steps B and C, as above and check again for a firm connection.

**E.** Connect the fixture wire from group B to the white wire from the outlet box in the same manner.

**STEP 4:**

**GROUNDING INSTRUCTIONS:** The green grounding screw (J) is to be inserted into the hole with two raised dimples provided on the mounting bar (A). Wrap the ground wire from the fixture (if supplied) and the ground wire from the outlet box (bare metal or green insulated wire) around the green grounding screw (J) on the mounting bar (A) and tighten the green grounding screw (J) to secure. **NEVER CONNECT GROUND WIRE TO BLACK OR WHITE POWER SUPPLY WIRES.**

**FINAL ASSEMBLY**

**Make sure no bare wires can be seen outside wire connectors.**

**STEP 5:**

Make sure no bare wires can be seen outside wire connectors. After wires are connected, tuck them carefully inside outlet box. Push the fixture firmly over the mounting nipple (B) and against the wall. Secure canopy (D) in place with cap nut (E).

**STEP 6:**

Place glass (F) over socket (I) and secure in place by threading glass retaining ring (G) onto socket (I).

**STEP 7:**

Install self ballasted lamp (H) by gently twisting into socket (I).

**FIXTURES WITH A ONE PIECE LAMP / BALLAST COMBINATION**

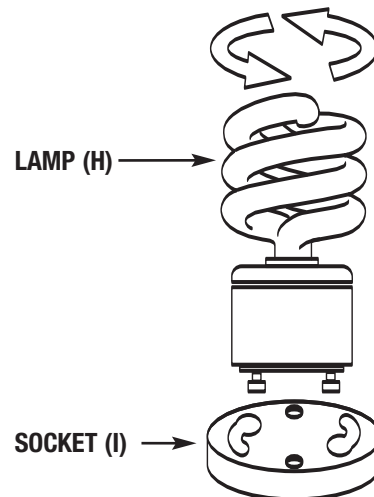

**FIGURE 2**