

# INSTALLATION AND SAFETY INSTRUCTIONS

## FOR YOUR SAFETY

**WARNING: BE SURE THE ELECTRICITY TO THE WIRES YOU ARE WORKING ON IS SHUT OFF. EITHER THE FUSE REMOVED OR THE CIRCUIT BREAKER OFF.**

## GENERAL

You don't need special tools to install this fixture. Be sure to follow the steps in the order given. Read instructions carefully. **If you are unclear as to how to proceed, consult a qualified electrician.**

**NOTE: Proper wiring is essential for the safe operation of this fixture.**

## ASSEMBLY

### STEP 1:

Carefully remove the fixture from the carton and check that all parts are included, as shown in Figure 1 & 2. Be careful not to misplace any of the screws or parts which are needed to install this fixture.

### WARNING

**NOTE: DO NOT INSTALL ON A POST OR A POLE THAT RESULTS IN A VERTICAL RISE OF 25 FEET OR HIGHER.**

**NOTE: This glass is handcrafted, the slight imperfections in the glass add to the authenticity of the fixture.**

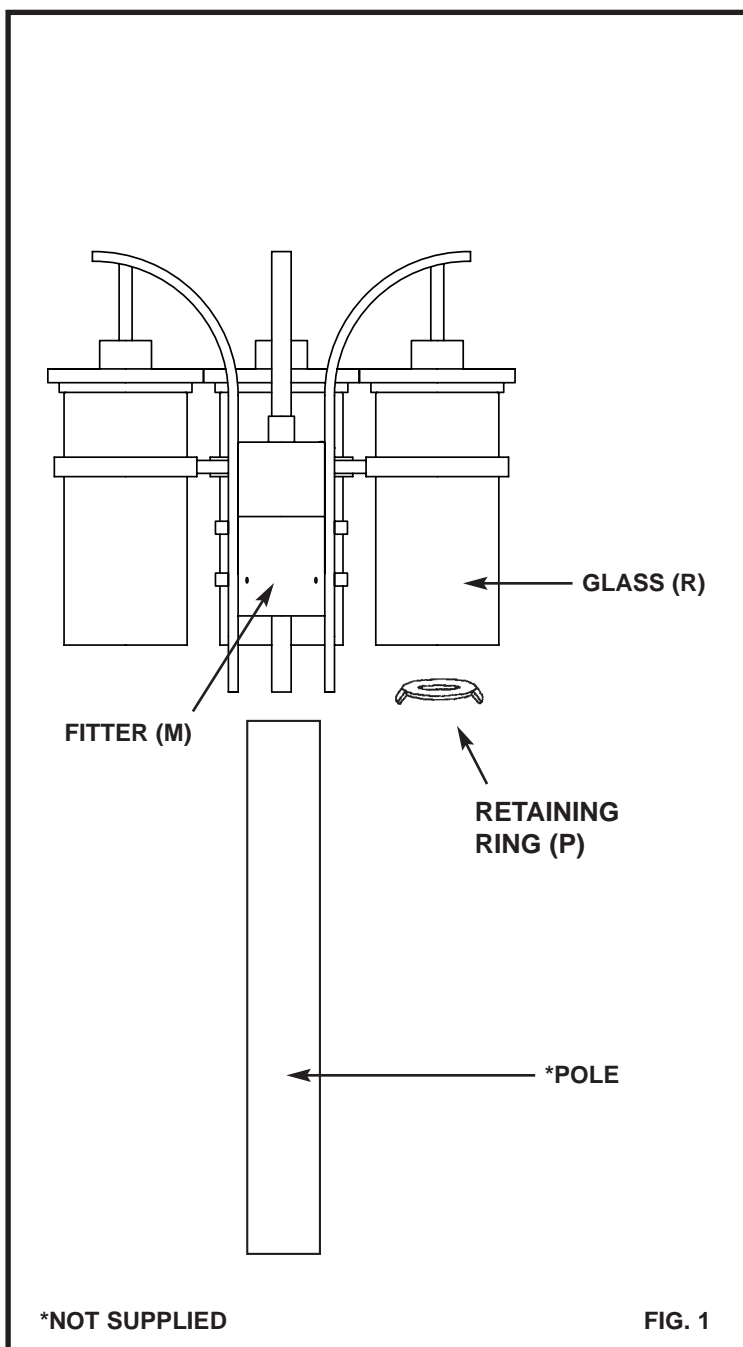

**NEW**

**sea gull lighting®**

**Installation And  
Safety Instruction**

**HC-876**      072704

Fill In Item Number On Carton And  
File This Sheet For Fixture Reference. ITEM# \_\_\_\_\_





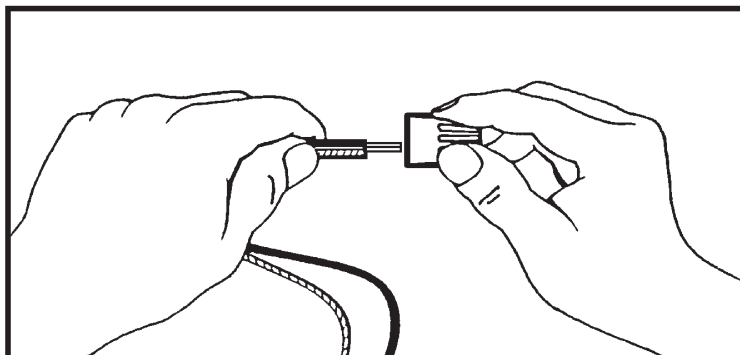

## INSTALLATION

HC-876

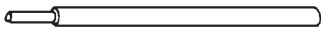
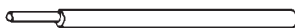
### STEP 1:

A. Take note of the color of the wire(s) on your fixture. Identify which group your fixture wire(s) falls into and connect the wires according to the directions below:



GROUP A: CONNECT TO BLACK HOUSE WIRE	GROUP B: CONNECT TO WHITE HOUSE WIRE
BLACK 	WHITE 
*PARALLEL WIRE (ROUND & SMOOTH) 	*PARALLEL WIRE (SQUARE & RIDGED) 
WHITE OR GREY WITH TRACER 	WHITE OR GREY WITHOUT TRACER 
BROWN, GOLD OR BLACK WITHOUT TRACER 	BROWN, GOLD OR BLACK WITH TRACER 

\*NOTE: When parallel wire is used, the tracer wire is square shaped or ridged, and the less tracer wire is round in shape or smooth. (Seen best when viewed from wire end.) To separate wires, grasp the ends of each wire and pull apart.

B. Take your fixture wire(s) from group A and place evenly against the black wire from the outlet box. **Do Not** twist wires together before using wire connectors.

C. Fit a wire connector (not supplied) over the wires and screw the connector clockwise until you feel a firmness.

D. Try gently to pull the connector off the wires. If you can pull the connector off, carefully re-do steps B and C, as above, and check again for a firm connection.

E. Connect the fixture wire from group B to the white wire from the outlet box in the same manner.

### STEP 2:

#### GROUND INSTRUCTIONS:

Connect the ground wire from the fixture (bare metal or green insulated wire) to the ground wire from the power supply (bare metal or green insulated wire) using a small wire connector (not supplied).

**NEVER CONNECT GROUND WIRE TO BLACK OR WHITE POWER SUPPLY WIRES.**

### STEP 3:

Slide fitter (M) onto post. Secure in place with screws (not supplied).

## FINAL ASSEMBLY

**Make sure no bare wires can be seen outside wire connectors.**

### STEP 1:

Raise glass (R) to socket and secure with retaining ring (P).

### STEP 2:

Install lamps.

## CLEANING

To clean, wipe fixture with a soft cloth. Clean glass with a mild soap. Do not use abrasive materials such as scouring pads or powders, steel wool or abrasive paper.

## ORDERING PARTS

Keep this sheet for future reference, and in case you need to order replacement parts. All parts for this fixture can be ordered from place of purchase. Be sure to use exact wording from illustration when ordering parts.