

INSTALLATION AND SAFETY INSTRUCTIONS

FOR YOUR SAFETY

WARNING: BE SURE THE ELECTRICITY TO THE WIRES YOU ARE WORKING ON IS SHUT OFF; EITHER THE FUSE REMOVED OR THE CIRCUIT BREAKER SET AT OFF.

GENERAL

You don't need special tools to install this fixture. Be sure to follow the steps in the order given. Under no circumstances should a fixture be hung on house electrical wires, nor should a swag type fixture be installed on a ceiling which contains a radiant type heating system. Read instructions carefully. **If you are unclear as to how to proceed, consult a qualified electrician.**

ASSEMBLY

Carefully remove the fixture from the carton and check that all parts are included, as shown in figure 1 and 2. Be careful not to misplace any of the screws or parts which are needed to install this fixture.

FIGURE 1

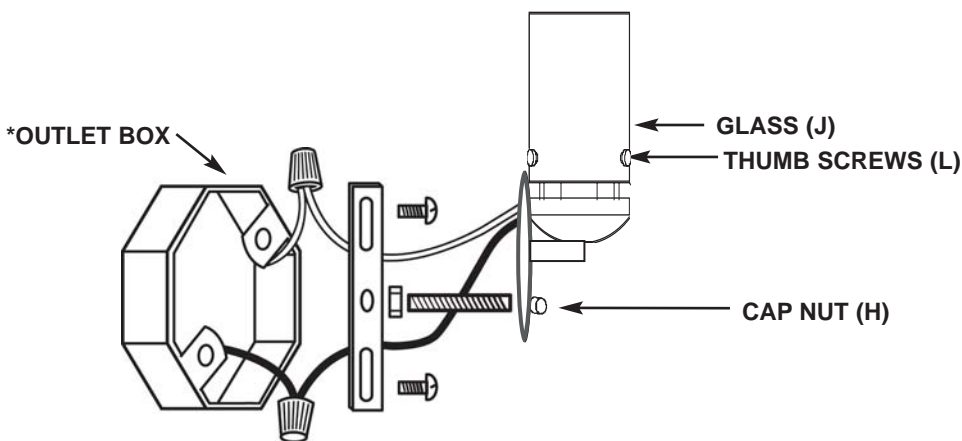

*NOT INCLUDED

GROUNDING AND MOUNTING BAR LOCK UP

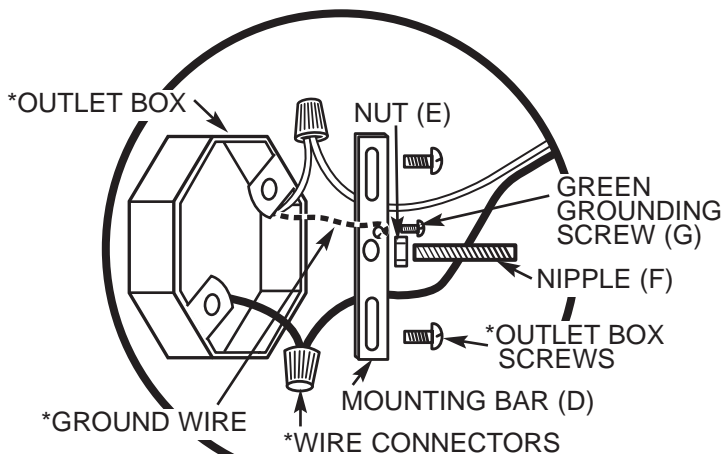

*NOT INCLUDED

FIGURE 2



sea gull lighting®

**Installation And
Safety Instruction**

HC-685

082703

Line art shown may not exactly match the fixture enclosed. However, the installation instructions do apply to this fixture. Fill In Item Number On Carton And File This Sheet For Fixture Reference. ITEM# _____

IMPORTANT: DO NOT ATTACH FIXTURE DIRECTLY TO OUTLET BOX.

STEP 1:

Using outlet box screws (not supplied) fasten mounting bar (D) to outlet box through slots in mounting bar (D).





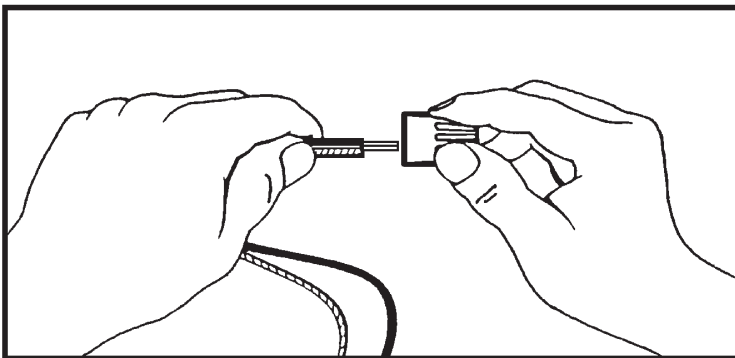

STEP 2:

Thread nut (E) onto nipple (F) so that 5 threads are exposed above nut (E). Thread that end of the nipple (F) into mounting bar (D) and tighten nut (E) against mounting bar (D).

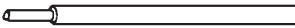
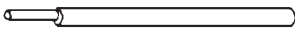
STEP 3:

A. Take note of the color of the wire(s) on your fixture. Identify which group your fixture wire(s) falls into and connect the wires according to the directions below:



GROUP A: CONNECT TO BLACK HOUSE WIRE	GROUP B: CONNECT TO WHITE HOUSE WIRE
BLACK 	WHITE 
*PARALLEL WIRE (ROUND & SMOOTH) 	*PARALLEL WIRE (SQUARE & RIDGED) 
WHITE OR GREY WITH TRACER 	WHITE OR GREY WITHOUT TRACER 
BROWN, GOLD OR BLACK WITHOUT TRACER 	BROWN, GOLD OR BLACK WITH TRACER 

*Note: When parallel wire is used, the tracer wire is square shaped or ridged and less tracer wire is round in shape or smooth. (Seen best when viewed from wire end.) To separate wires, grasp the ends of each wire and pull apart.

B. Take your fixture wire(s) from group A and place evenly against the black wire from the outlet box. **DO NOT** twist wires together before using wire connectors.

C. Fit a wire connector (not supplied) over the wires and screw the connector clockwise until you feel a firmness.

D. Try gently to pull the connector off the wires. If you can pull the connector off, carefully re-do steps B and C, as above and check again for a firm connection.

E. Connect the fixture wire from group B to the white wire from the outlet box in the same manner.

STEP 4:

GROUNDING INSTRUCTIONS: The green grounding screw (G) is to be inserted into the hole with two raised dimples provided on the mounting bar (D). Wrap the ground wire from the fixture (if supplied) and the ground wire from the outlet box (bare metal or green insulated wire) around the green grounding screw (G) on the mounting bar (D) if uninsulated wire is on the mounting bar (D), connect the ground wire from the fixture (if supplied) and the outlet box to it using a small wire connector (not supplied).

NOTE: Underwriters Laboratories (U.L.) does not require all fixtures to have ground wires. These fixtures still meet all U.L. specifications. The listing mark of Underwriters on the product identifies products manufactured under its listing and Follow-Up Service Programs.

NEVER CONNECT GROUND WIRE TO BLACK OR WHITE POWER SUPPLY WIRES.

FINAL ASSEMBLY

STEP 1:

Make sure no bare wires can be seen outside wire connectors.

STEP 2:

After wires are connected, tuck them carefully inside outlet box. Push the fixture firmly over the mounting nipple (F) and against the wall. Secure canopy (I) in place with cap nut (H).

STEP 3:

Place glass (J) in holder (K) and secure in place by screwing thumb screws (L) to fixture bracket.

STEP 4:

Install lamps.

CLEANING

To clean, wipe fixture body with a soft cloth. Clean glass with a mild soap. Do not use abrasive materials such as scouring pads or powders, steel wool, or abrasive paper.

ORDERING PARTS

Keep this sheet for future reference, and in case you need to order replacement parts. All parts for this fixture can be ordered from place of purchase. Be sure to use exact wording from illustration when ordering parts.